

CD Color Printer IV

User's Manual

Notices: The information in this document is subject to change without notice.

NO WARRANTY OF ANY KIND IS MADE WITH REGARD TO THIS MATERIAL, INCLUDING, BUT NOT LIMITED TO, THE IMPLIED WARRANTIES OF MERCHANTABILITY AND FITNESS FOR A PARTICULAR PURPOSE. No liability is assumed for errors contained herein or for incidental or consequential damages in connection with the furnishing, performance, or use of this material. This document contains proprietary information which is protected by copyright. All rights are reserved. No part of this document may be photocopied, reproduced, or translated into another language without prior written consent.

Trademark Acknowledgments: IBM is a registered trademark of International Business Machines Corporation. Windows is a trademark of Microsoft Corporation. All other trademarks are the property of their respective owners. CandelaColor® Charged by Pictographics is a registered trademark of Pictographics International Corporation.

Printing History

Edition 1.4, #020602, © Copyright 2001, All rights reserved.

FCC Compliance Statement: This device complies with part 15 of the FCC rules. Operation is subject to the following two conditions: (1) this device may not cause harmful interference, and (2) this device must accept any interference received, including interference that may cause undesired operation.

For Users in the United States: This equipment has been tested and found to comply with the limits for a Class B digital device, pursuant to Part 15 of the FCC Rules. These limits are designed to provide reasonable protection against harmful interference in a residential installation. This equipment generates, uses, and can radiate radio frequency energy and, if not installed and used in accordance with the instructions, may cause harmful interference to radio communications. However, there is no guarantee that interference will not occur in a particular installation. If this equipment does cause harmful interference to radio or television reception, which can be determined by turning the equipment off and on, the user is encouraged to try to correct the interference by one or more of the following measures:

- Re-orient or relocate the receiving antenna.
- Increase the separation between the equipment and receiver.
- Connect the equipment into an outlet on a circuit different from that to which the receiver is connected.
- Consult the dealer or an experienced radio/TV technician for help.

Use of a shielded cable is required to comply with the Class B limits of Part 15 of the FCC Rules. You are cautioned that any changes or modifications not expressly approved in this manual could void your authority to operate and/or obtain warranty service for this equipment.

Within the U.S., this product is intended to be supplied by a UL Listed Direct Plug-in Power Unit marked Class 2 and rated 30 Vdc, 500 mA or 830 mA.

For Users in Canada: This digital apparatus does not exceed the Class B limits for radio noise for digital apparatus set out on the Radio Interference Regulations of the Canadian Department of Communications. Le présent appareil numérique n'émet pas de bruits radioélectriques dépassant les limites applicables aux appareils numériques de la class B prescrites dans le Règlement sur le brouillage radioélectrique édicté par le ministère des Communications du Canada.



CAUTION!

TO PREVENT FIRE OR SHOCK HAZARD, DO NOT EXPOSE THE UNIT TO RAIN OR MOISTURE.
TO REDUCE THE RISK OF ELECTRIC SHOCK, DO NOT REMOVE EXTERIOR PANELS. NO USER-SERVICEABLE PARTS INSIDE. REFER SERVICING TO QUALIFIED SERVICE PERSONNEL. OPERATE THE UNIT WITH ONLY THE PROPER ELECTRICAL SPECIFICATIONS AS LABELED ON THE PRINTER AND AC ADAPTER

Read Me First!

Congratulations on the purchase of your new CD Color Printer. To begin printing with your new printer immediately, please refer to the following quick start instructions. For more complete information regarding all aspects of your printer's operation, please refer to the printer's main User's Manual.

HARDWARE SETUP

1. Unpackage your printer, and check that the following items are included:
 - Power Adapter
 - Separate Power Cord (220-240V units only)
 - Printer Software CD
 - Color Ink Cartridge
 - Spare Ink Cartridge Holder
 - Cardboard CD Templates (5)
 - Warranty Statement and Registration Card
 - Operator's Manual and Other Printed Information
2. Connect your printer's power.
3. Install the included color ink cartridge by pressing the  Ink Cartridge Button and inserting the cartridge copper-end first into the ink cartridge carrier. Then, push the top of the cartridge back until it snaps into place. When the cartridge is in place, press the  Ink Cartridge Button again to reset the cartridge carrier.
4. Press the  CD Tray Button, and install one of the cardboard CD templates into the CD Tray.
5. Run a self test according to the instructions in Section 2-D of the printer User's Manual. This will ensure that both the printer and the ink cartridge are functioning properly. **This procedure should also be done whenever you install a new ink cartridge or if your printer has sat for a few days without printing.** If some of the nozzles do not seem to be firing, perform a clean operation after the printer driver has been installed. Refer to the cleaning procedure explained within the **Cartridge** button description of section 3-D in the manual to clean the cartridge nozzles.

The self-test should look like this:

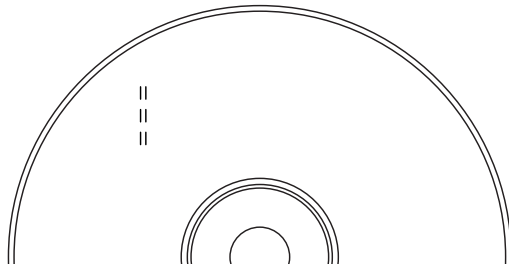

6. Connect the printer to your computer using the proper interface cable. For best results, use a IEEE 1284-Compliant cable and do not connect to an A/B switch box. Also, note that the printer will print fastest if your computer's parallel port is set to ECP mode (most new computers are set to ECP). Your computer's manual will have information on changing the parallel port mode if you need to switch it to ECP.

SOFTWARE INSTALLATION

Once you have set up your printer, you must then install all of the appropriate software required for printing. The included CD contains all of the necessary software. At a minimum, you must install the printer driver appropriate for your computer's specific operation system (Windows® 95/98/Me or Windows 2000/XP). Below is a description of the CD contents as well as installation instructions for each software component.

CD Contents:

- CD Color Printer Driver IV for Windows 95/98/Me
- CD Color Printer Driver IV for Windows 2000/XP
- 32-Bit Print Spooler for Windows 95/98/Me (provides optimum print processing under Windows 95/98/Me)
- 2 Sample CD Designs (TIFF format)

Installation Instructions:

Windows 95/98/Me or 2000/XP Printer Drivers:

1. Insert the included CD into your computer's CD-ROM drive.
2. Click on the **Start** button on the task bar, point to **Settings**, and select **Printers**.
3. Double-click on the **Add Printer** icon. This will launch the Add Printer Wizard. Click **Next**, then click **Next** again.
4. Click the **Have Disk** button.
5. Click **Browse**, select your CD-ROM drive.
6. For Windows 95/98/Me, open the **Win98-Me** folder, then select the **Driver** folder and select the file named **CDCOLOR4.INF**. For Windows 2000 or Windows XP, open the **Win2000-XP** folder and select the file named **OEMSETUP.INF**.

*(Example: If you are installing the Windows 95/98/Me, and your CD-ROM drive is drive D:, then you would browse to: D:\Win98-Me\Driver. You would then select the file named **CDCLOR4.INF**). Follow the on-screen instructions to complete installation.*

32-Bit Print Spooler: (MUST INSTALL if using Windows 95/98/Me only)

1. Insert the included CD into your computer's CD-ROM drive.
2. Close down all other software applications.
3. Click the **Start** button, point to **Settings**, and select **Control Panel**.
4. Double-click on the **Add/Remove Programs** icon, and select the **Install** button.
5. Click **Next**, then click on the **Browse** button.
6. Select your CD-ROM drive, open the folder named **Win98-Me**, then open the folder named **32-Bit Print Spooler**.
7. Double-click on the **Setup.exe** file then select the **Finish** button to complete installation.

Please Note

The Spare Ink Cartridge Holder provides a convenient place to store an extra ink cartridge and also prevents an opened ink cartridge from drying out. To use this holder, simply set it next to the printer. The Spare Ink Cartridge Holder must always remain in an upright or vertical position. Insert an Ink Cartridge into the holder, copper-end first, until it snaps into place. To remove the Ink Cartridge, push back on the holder's securing tab and lift the Ink Cartridge out.

Please Note

To fully utilize CD Color Printer IV's high-speed printing, you must set your PC parallel printer port to the ECP setting. Otherwise, you may find that print speed is up to 50% slower than you might expect.

Please refer to your computer system's documentation for instructions on enabling ECP. It is almost always found in the CMOS settings which are entered upon power-up.

Interactive Feature in this PDF Document

There are interactive features that will allow you to jump to different locations within the document. Each listing in the Table of Contents is interactive. Place the cursor on either the words or the page number. A small hand with a pointing finger icon appears. Click on the line with the icon and the document will jump to that page. If you want to return to the Table of Contents, move the icon to the top of the page and click on the arrow marked TOC. Navigating through the Index is similar. Place the icon on one of the listings or page numbers, click on it, and it will move to that page. The text relating to the Index listing will appear in red. Returning to the Index can be done by clicking on the arrow marked Index.

Table of Contents

Section 1: Getting Started	
A. Choosing a Good Location.....	1
B. Unpacking and Inspection	1
C. Identifying the Parts.....	2
D. Applying Power.....	3
Section 2: Ink Cartridges and Printable CDs	
A. About Ink Cartridges and Printable CDs	4
B. Installing an Ink Cartridge	4
C. Loading Blank CD Media.....	6
D. Printing a Self Test.....	7
E. Replacing or Switching Ink Cartridges.....	8
Section 3: Using the CD Color Printer IV with Windows	
A. Connecting the Printer to Your Computer	11
B. Installing the Printer Driver.....	12
C. Installing the 32-Bit Spooler for Windows 95/98/Me.....	14
D. Setting Up the Printer Driver	16
E. Printing a CD.....	24
Section 4: Interpreting the Printer Indicator Lights.....	26
Section 5: Maintaining the Printer	
A. Cleaning the Ink Cartridge Nozzles.....	28
B. Cleaning the CD Tray and Printer Casing.....	28
C. Clearing a CD Media Jam	28
D. Technical Support	28
Section 6: Technical Specifications	29
Appendix A: Interfacing Information	
A. Introduction.....	30
B. 6-Pin Minicircular Auxiliary Interface	31
Index	32

Section 1: Getting Started

THANK YOU...

...for choosing the CD Color Printer IV. This printer is the perfect way for you to label all of your custom CDs quickly, easily, and with a touch of class. The CD Color Printer IV lets you print razor-sharp text, vibrant spot colors, and even stunning photo-realistic photographs directly onto the surface of printable CDs. Operation is simple, quality is high, and printed images are durable and highly smudge-resistant.

To begin using the printer, please refer to the remainder of this manual. This User's Manual is your complete step-by-step guide to quickly and easily setting up and printing with your new CD Color Printer!

A. CHOOSING A GOOD LOCATION

- Place the printer in a location with adequate air circulation to prevent internal heat build up.
- Do not place the printer near heat sources such as radiators or air ducts, or in a place subject to direct sun-light, excessive dust, mechanical vibration or shock.
- Allow for adequate clearance in front of the printer to accommodate the length of the unit with its CD Tray open.

B. UNPACKING AND INSPECTION

While unpacking your printer, inspect the carton to ensure that no damage has occurred during shipping. Make sure that all supplied accessories are included with your unit. The following items should be included:

- Printer
- PowerAdapter
- Separate Power Cord (220-240 VAC units only)
- Printer Software CD
- Color Ink Cartridge
- Spare Ink Cartridge Holder

- Cardboard CD Templates (5)
- Warranty Statement and Registration Card
- This manual and other printed information

Save the carton and packing materials. They will come in handy when transporting the printer.

C. IDENTIFYING THE PARTS

This illustration shows the extended CD Tray and all of the control buttons and LED indicator lights found on the printer.

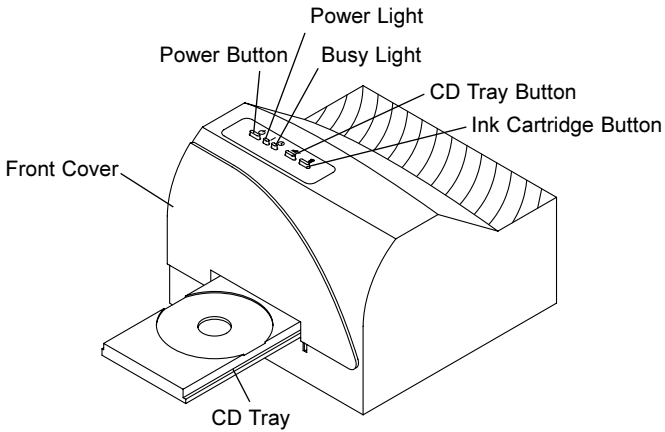

The **⏻ Power Button** turns the printer's power ON and OFF. This button also serves to cancel the current print job if a print error occurs and to reset the printer for the next print job.

The **📀 CD Tray Button** opens or closes the **CD Tray** for loading and ejecting CDs.

The **🖨️ Ink Cartridge Button** positions the Cartridge Carrier for easy ink cartridge replacement.

The **| Power Light** indicates that power is ON. The **⊙ Busy Light** indicates that the printer is printing, processing, or is in some way busy. Both of these lights can also indicate several other printer conditions. For complete information on these lights, please refer to Section 6.

This illustration shows the input ports found on the rear panel of the printer. Both a parallel and a serial **interface port** are provided. If using the printer with Windows, you will use its **Parallel Interface Port**. Note that the printer's **auxiliary port** is for use with auto loaders and automatic duplicators only, which are sold separately. For more information on each of the interface ports, please refer to Appendix A.

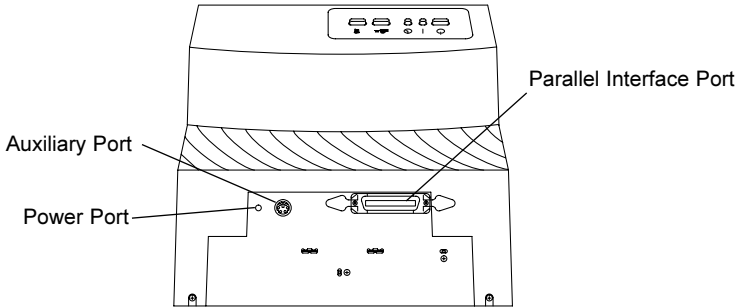

D. APPLYING POWER

1. Locate the power adapter supplied with your printer.
2. Place one end of the adapter cord into the power port on the rear panel of the printer.

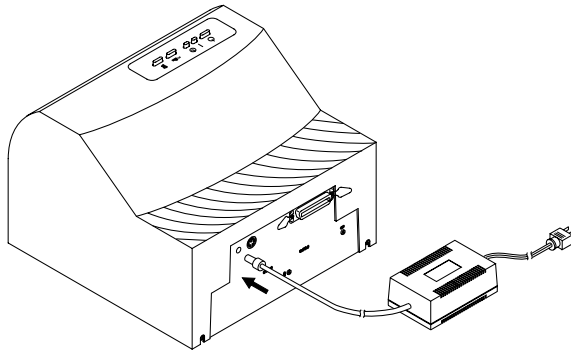

3. Plug the power cord of the adapter into an available wall outlet. Once the power cord is connected, the printer will automatically turn ON.

Section 2: Ink Cartridges and Printable CDs

A. ABOUT INK CARTRIDGES AND PRINTABLE CDS

For full-color printing, a 3-color **ink cartridge** is available. This cartridge contains the three process-color inks of yellow, magenta, and cyan, which combine to produce up to 16.7 million printable colors. A monochrome ink cartridge is also available for fast, inexpensive black and white printing.

With either of these ink cartridges, you can print directly onto virtually any brand of **printable-surface CD** media. Since different brands of **CDs** have different printable coatings, however, you may need to adjust the printer driver settings to accommodate your specific brand of CD media. Refer to Section 3 for further printer driver information.

Due to the wide variety of printable-surface CD media, you may find that certain brands of CDs provide higher print quality than others. For maximum print quality, use CD media authorized by the printer manufacturer. Contact your local CD Color Printer reseller or contact the printer manufacturer directly for selection and pricing on all printer supplies and accessories.

B. INSTALLING AN INK CARTRIDGE

1. With the CD Tray closed, open the printer's front cover by pulling down on its top-left corner.

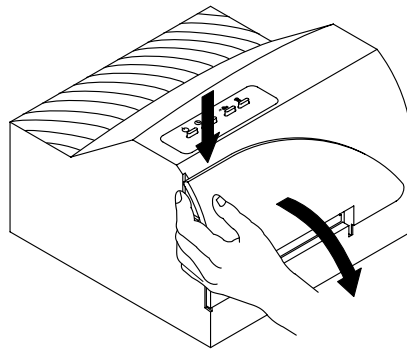

2. Remove the ink cartridge from its packaging.

3. Slowly remove the tape covering the cartridge's printhead, being careful to avoid damaging or removing the barcode label on the underside of the cartridge.
DO NOT TOUCH THE COPPER AREA!

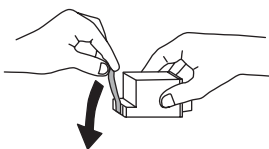

4. Press and release the  Ink Cartridge button to move the carrier to the load position.
5. Insert the ink cartridge into the cartridge carrier, copper end first. **DO NOT REMOVE THE COLOR BARCODE LABEL!**

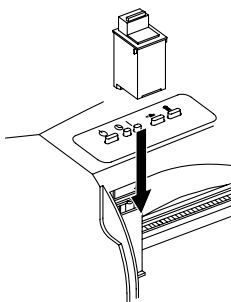

6. Push the cartridge back until it snaps into place.

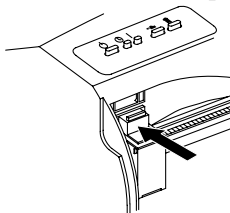

7. Close the printer's front cover. If you leave the door open, ambient light can interfere with proper cartridge initialization.
8. Press and hold the  Ink Cartridge button until the carriage returns home, then release. This will reset the on board ink levels.

NOTE: When changing to subsequent new cartridges, refer to Section E.



NOTE: A Spare Ink Cartridge Holder is included with your printer. This holder provides a convenient place to store an extra ink cartridge and also prevents an opened ink cartridge from drying out. To use this holder, simply insert an Ink Cartridge into the holder, copper-end first, until it snaps into place.

C. LOADING BLANK CD MEDIA

The CD Color Printer IV is capable of printing onto a variety of CD related media including printable CDs and DVDs, and cardboard CD templates. Each of these items is loaded one at a time, before the start of each print job.

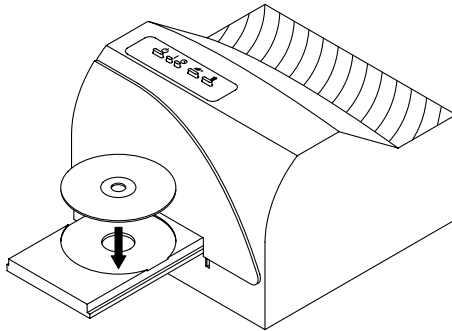
Loading a Blank CD





1. With the printer's front cover shut, press and release the  CD Tray button.
2. Once the CD Tray is fully extended, place the blank CD onto the tray with the printable side facing upward. Handle the CD only along its edges and **DO NOT** touch its printable surface.
3. Press and release the  CD Tray button to close the CD Tray. If you wish, you may also leave the CD Tray open and it will automatically close at the start of the print job. Once the CD has been printed, the CD Tray will automatically re-open so the next blank CD can be loaded (if Manual Load is selected in the printer driver then you must press the CD Tray button to manually open and close the tray).

NOTE: Blank Cardboard CD templates are available for printing inexpensive test prints and can be printed on both sides. Load in the exact same fashion as an actual CD.

D. PRINTING A SELF TEST

Now that the printer is set up and print supplies are loaded, a **self test** should be performed to check for proper operation of the printer. A sample of the self test print is shown below.

Refer to the following steps to run a self test:

1. If power is ON, turn it OFF now. The Power light should be OFF. Verify that print supplies are installed and that the CD Tray is closed. Also, disconnect the interface cable from the printer if connected.
2. With the printer's front cover shut, press and hold the  CD Tray button as you turn the printer power ON.
3. Continue to hold the  CD Tray button down for a few seconds, until you hear the self test begin to print.

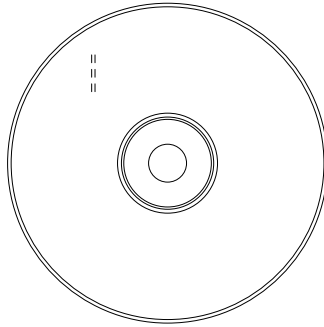

E. REPLACING OR SWITCHING INK CARTRIDGES

Once you begin using your CD Color Printer IV on a regular basis, you will eventually need to replace an empty ink cartridge or switch between color and monochrome cartridges. Please refer to the following steps:

1. With the CD Tray closed, open the printer's front cover by pulling down on its top-left corner.

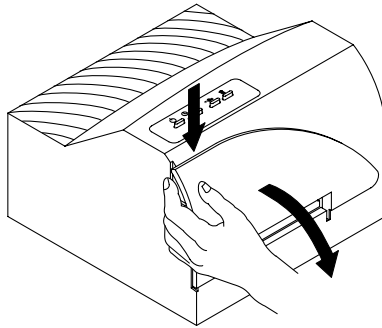

2. If installing a new, replacement ink cartridge, slowly remove the tape covering the cartridge's printhead, being careful to avoid damaging or removing the barcode label on the underside of the cartridge. **DO NOT TOUCH THE COPPER AREA!**

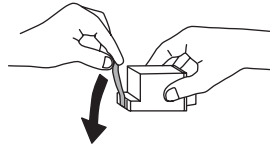

3. If switching between color and monochrome cartridges, simply remove the extra cartridge from the Spare Ink Cartridge Holder by grasping the top of the cartridge and firmly pulling it straight toward you. You will hear the cartridge snap out of position. **DO NOT REMOVE THE BARCODE LABEL!**

- From within the printer driver setup window, click on the **Cartridge** button and then on the **Change** button to move the carrier to the load position. Note that the printer driver must be installed and that the printer must be connected to your computer (see Section 3) in order to complete this step.

If you prefer, you may instead press the Ink Cartridge button on the top of the printer.

- Remove the installed ink cartridge by grasping the top of the cartridge and firmly pulling it straight toward you. You will hear the cartridge snap out of position. Remove it from the printer.

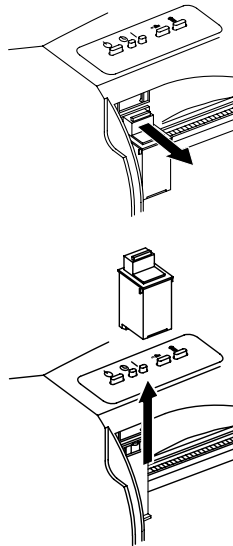

- Insert the replacement or alternate ink cartridge into the cartridge carrier, copper-end first.

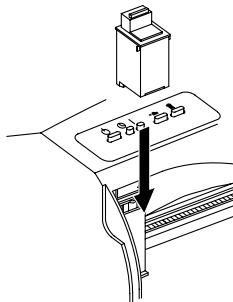

7. Push the cartridge back until it snaps into place.

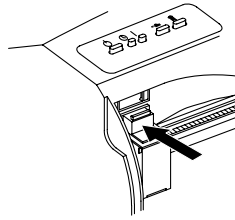

8. Close the printer's front cover.
9. Go back to the printer driver setup window and click on either the **New Cartridge Installed** or the **Old Cartridge Installed** button to indicate whether you installed a fresh, new cartridge or simply switched between a previously used color cartridge and a previously used monochrome cartridge. The cartridge carrier will return to its home position. See Section 3-D for more information on these buttons.

Alternately, you may use the Ink Cartridge button; to indicate a previously used cartridge simply press the button and release quickly. If you have installed a fresh new cartridge, press and hold the button until the cartridge returns to its home position.

NOTE: When you choose *New Cartridge*, the ink levels are cleared and the ink level indicator should go back to full capacity (for either color or monochrome).

If you use the Ink Cartridge button, the ink levels are cleared by pressing and holding the button until the two green LED's flash and the cartridge returns to its home position.

NOTE: Front door must be closed for printer to recognize the cartridge.

Section 3: Using the CD Color Printer IV with Windows

A. CONNECTING THE PRINTER TO YOUR COMPUTER

The CD Color Printer IV is designed to be used with nearly any IBM-PC® or compatible running Windows 2000/XP, or Windows 95/98/Me.

The printer is equipped with a standard 8-bit Centronics-type **parallel port**. This port is the means through which it receives data from your computer. To connect the printer to your computer, simply obtain a shielded, bi-directional parallel cable, and refer to the following steps:

NOTE: For faster printing, your computer's parallel port mode should be set to ECP. If you experience problems with this setting or if your computer's parallel port is not ECP compatible, set your computer's parallel port to the standard "Printer Port" setting. Refer to your computer's system documentation for instructions on checking and/or changing the parallel port mode.

1. Connect the Centronics-type parallel side of the cable to the printer. Snap the fastening clips into place.

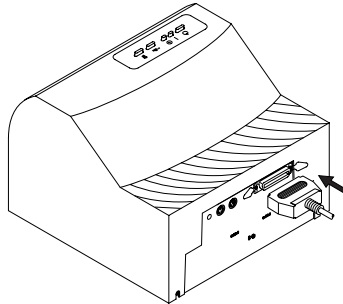

2. Connect the other side to the back of your computer at LPT1, LPT2, or the PARALLEL connector.

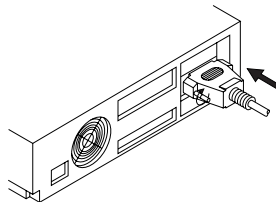

The printer must have its Power light illuminated to receive data. If the light is not on, press the  Power button.

B. INSTALLING THE PRINTER DRIVER

The CD Color Printer IV can be used with virtually any Windows application program. This is accomplished by installing in Windows what is called a “**printer driver.**” The printer driver is simply software which gives the printer all the information needed for printing. Use the following steps to install the printer driver.

NOTE: *This section of the Operator’s Manual assumes that you are already familiar with Windows and know how it operates. If you are not yet familiar with Windows, consult the appropriate Microsoft documentation to become familiar with the basics of Windows before proceeding.*

Windows 95/98/Me or Windows 2000/XP

To install the printer driver into Windows 95/98/Me or Windows 2000/XP, refer to the following:

1. Insert the included CD into your computer’s CD-ROM drive.
2. Click the **Start** button, point to **Settings**, and select **Printers**.

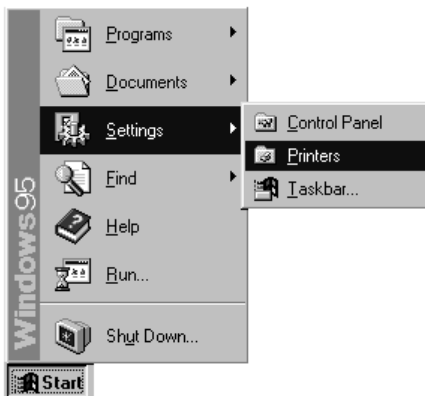

3. Double-click on the **Add Printer** icon. This will launch the Add Printer Wizard. Click **Next**, then click **Next** again.



4. Click the **Have Disk** button.
5. Click **Browse**, select your CD-ROM drive.
6. For Windows 95/98/Me, open the **Win98-Me\Driver** folder and select the file named **CDCOLOR4.INF**. For Windows 2000/XP, open the **Win2000-XP** folder and select the file named **OEMSETUP.INF**. (*Example: If you are installing the Windows 95/98/Me driver, and your CD-ROM drive is drive D:, then you would browse to: D:\Win98-Me\Driver. You would then select the file named CDCOLOR4.INF.*) Follow the on-screen instructions to complete installation. Once installed, the "CD Color Printer III" icon will appear in the Printer's folder.



CD Color Printer IV

IMPORTANT! *During installation of the Windows 2000 and XP drivers you must de-select (uncheck) the check box "Automatically detect and install my plug and play printer".*

NOTE: *Before installing updated printer driver versions, always delete the existing printer driver version from your system. To do this, simply select the printer driver icon from within the Printers folder, and press the Delete key.*

C. INSTALLING THE 32-BIT PRINT SPOOLER FOR WINDOWS 95/98/ME

Your CD Color Printer IV ships with a print utility program called the **32-Bit Print Spooler**. This print spooler is for use only with Windows 95, Windows 98, or Windows Me. Once installed, the print spooler is able to process your print jobs and send them to the printer at consistently faster speeds than if sending print jobs through the Windows system print spooler. This is especially true if printing from a somewhat slower computer. As a result, it is highly recommended that you use the 32-Bit Print Spooler when printing from Windows 95, Windows 98, or Windows Me.

Also, the 32-Bit Print Spooler will display the ink remaining in your printer and also the number of prints remaining before the printer gives an ink low warning.

The 32-Bit Print Spooler is located on the included Printer Software CD and installs just like any other standard Windows application program. To install the 32-Bit Print Spooler, refer to the following:

1. Insert the included CD into your computer's CD-ROM drive.
2. Close down all other software applications.
3. Click the **Start** button, point to **Settings**, and select **Control Panel**.

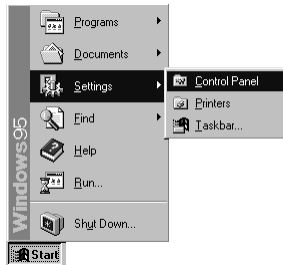

4. Double-click on the **Add/Remove Programs** icon, and select the **Install** button.

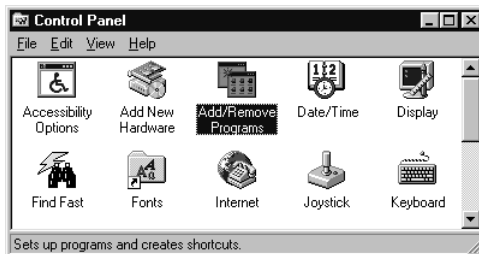

5. Click **Next**, then click on the **Browse** button.
6. Select your CD-ROM drive, then open the folder named **32 Bit Print Spooler**.
7. Double-click on the **Setup.exe** file, then select the **Finish** button to complete installation. When installed, the 32-Bit Print Spooler icon will appear in the Programs group of the Start menu.



NOTE: Before installing updated 32-Bit Print Spooler versions, always uninstall the existing print spooler version from your system. To do this, simply select 32-Bit Print Spooler from the list of programs in the Add/Remove Programs Properties window and click on the **Add/Remove** button.

To print with the 32-Bit Print Spooler, you must select the **Use 32-Bit Spooler** option from within the printer driver setup window as described in Part D of this section. When this option is selected, the print spooler will automatically open and close with the start and finish of each print job.

NOTE: You can also manually open the 32-Bit Print Spooler simply by selecting its icon from the Programs group of the Start menu.

When the 32-Bit Print Spooler is running, its icon will appear in the Windows 95/98/Me Task Bar. During a print job, it is sometimes helpful to click on this icon to bring the 32-Bit Print Spooler status window to the foreground of your application. This window provides a number of details about the print jobs being sent to the printer.

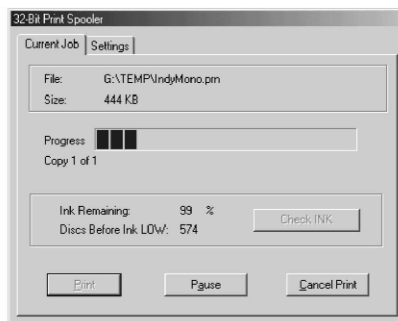

The **Current Job** tab tells you the name and size of the file printing, the progress of the overall print job, as well as the total number of copies left to print. It also provides buttons which allow you to pause or cancel the print job at any time during the printing process. For the CD Color Printer IV it also gives ink remaining information.

The **Settings** tab tells you the port and printer to which you are printing and allows you to configure the timeout settings. These settings will rarely need to be changed. This tab also provides two other options called **Save last job for reprint** and **Direct to Port Mode**.

When the **Save last job for reprint** option is selected, the 32-Bit Print Spooler will automatically save the last print job you sent to the printer and allow you to instantly reprint the job without the delay of having to reprocess it. The print job will be saved in the spooler until another print job is sent and saved over it. If you do not wish to save the last print job for reprint, deselect this option. To print a saved job, simply select the **Print** button from the spooler's Current Job tab.

HINT: *If you want to send the last job without having to rasterize it again, simply open the 32-Bit Spooler and click print.*

The **Direct to Port Mode** option allows the spooler to send data to the printer at its optimum speed. If, however, you experience problems when printing with this option selected, simply deselect it and try your print job again. Please note that when using this option your PC will be completely locked up while printing.

The **Job Queue tab** appears only when a print job is being sent to the printer. This tab tells you the name and status of each job in the queue and shows you the order in which the jobs will print if you have sent multiple jobs to the printer. A control button is also provided which allows you to delete every job listed in the queue. To delete the job currently being printed, simply select the **Cancel Print** button under the Current Job tab.

D. SETTING UP THE PRINTER DRIVER

Once the printer driver has been successfully installed, you will need to set the driver up with the appropriate print options. Refer to the following steps to change or verify your printer driver options:

1. Click the **Start** button, point to **Settings**, and select **Printers**. Then, click on the **CD Color Printer IV** icon with the right mouse button and select **Properties** if using Windows 95/98/Me or **Document Defaults** if using Windows NT, or **Printing Preferences** if using Windows 2000.

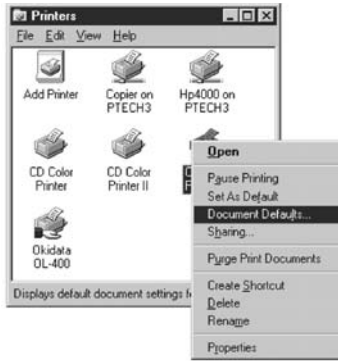

2. In Windows 95/98/Me, you will see several tabs from which printer settings can be changed including **Media**, **Device Options**, **Cartridge**, and **Calibrate**. In Windows NT, click on the **Advanced** tab of the Document Settings window. In Windows 2000/XP click on the **Advanced** button for more driver settings.



NOTE: Most applications allow you to change these same printer driver options from their “Print” and/or “Printer Setup” screens. This means that you don’t have to go back to the main printer setup window each time you want to change a setting or option in the printer driver. These applications will usually give you the same choices and options, but in a slightly altered format.

3. In Windows 95/98/Me, you must click on one of the four tabs to see the printer setting options; each tab contains different printer settings. In Windows 2000 the Layout and Paper/Quality tabs appear; the Advanced button contains more printer driver settings. Although each printer driver displays the print options in a slightly different format, the basic options are the same. Refer to the remainder of this section for a description of each printer driver option.

Media

The media option will be set to CD for printing onto printable surface CDs, DVDs, and cardboard template CDs. When sizing your images for printing, keep in mind that each type of CD media has the following maximum printable areas:
CD 4.567" round (116mm). For a complete description of each type of print media and to see how each is installed, refer to Section 2.

Ink Cartridge

Select either **Color** or **Monochrome** according to the type of ink cartridge you have installed.

Print Quality

Select the appropriate print quality option for your image. Keep in mind that **Fast 600** provides the lowest quality but fastest print, and that **Super Photo** provides the highest quality but slowest print. You may wish to experiment with these options to see which one is best for your particular CD media and print quality parameters.

Dither Mode

Select this option to choose the appropriate dither mode for your image. Select **Optimize for photos** if printing a design primarily composed of photographic images. Select **Optimize for graphics** if mainly printing text, lines, and graphics.

Color Matching

Click on the Color Matching down arrow and choose the color matching option that's right for you. Select **None** if you are more interested in print speed rather than color accuracy, if you have already color corrected your image for printing, or if you are using some other third party color matching software.

Select **Algebraic** if you would like the printer driver to make very simple color balance adjustments based on an RGB color model. This option gives you more natural looking images without actually utilizing any specific color matching software.

Select **PrimaColor** to enable color matching profiles written specifically for the CD Color Printer IV. The PrimaColor by Candela Color Management System automatically adjusts the

color of your image according to preconfigured printer profiles and default system profiles. This results in a very precise color match compliant with ICC standards.

Ink Saturation

This option controls the ink saturation of the printed image. When printing onto the printer manufacturer's TuffCoat CD media, this option can be left at its default setting of 50%. When printing onto other brands of printable CD media, you may need to adjust this control in order to optimize the ink saturation for the printable surface of your specific CD media. Click and drag on the slide's box, or click on the left and right arrows to change the ink saturation setting. Moving the slide's box to the left reduces the overall ink saturation, while moving it to the right increases it.

Manual Load

Select this option when you are printing multiple copies of a single design or if using an auto-loader. If you do not select this option when printing multiple copies, the printer has no way of knowing whether or not you have loaded a blank CD and will print each of the selected number of copies onto the same CD. When this option is selected, you must press the  CD Tray button after each new CD blank is loaded. This will close the CD Tray and let the printer know that a fresh CD is installed and ready to be printed.

Write Direct to Port

Select this option to provide faster print processing if printing from Windows 95/98/Me. When selected, this option allows the printer driver to bypass the Windows 95/98/Me print manager and to send all print data directly to the printer. This option devotes all of your system resources to the current print job, thereby increasing overall print speed. When the print job is finished, your system resources will again be devoted to the normal function of your on-screen applications.

Depending upon the brand of your computer, you may or may not wish to select this option when printing. For some computers, selecting this option will enhance the rasterizing and printing process. In this case, the **Write Direct to Port** option may be selected. For some computers, however, this option may not be supported and should not be selected.

Use 32-Bit Spooler

Select this option for consistently faster print processing under Windows 95/98/Me. This option is only selectable if operating under Windows 95/98/Me and if the included **32-Bit Print Spooler** software has been installed. When selected, this option allows the printer driver to send all print jobs to the 32-Bit Print Spooler rather than to the Windows system print spooler. See Part C of this section for complete details on the 32-Bit Print Spooler. This option and the 32-Bit Print Spooler software will not function in Windows 2000 or XP.

Cartridge

Select this button to display the type of ink cartridge currently installed, its current ink levels, as well as options for cleaning and changing a cartridge. Note that the ink cartridge type installed and ink levels can only be reported when operating under Windows 95/98/Me and only if the 32-Bit Print Spooler has been installed.

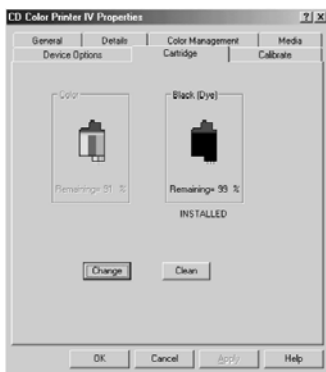

Select the **Clean** button to send a simple test print pattern to the printer. Be sure to have a CD template installed. This test print pattern purges the ink cartridge nozzles and lets you know if any one of the Yellow, Magenta, or Cyan nozzles is clogged. If one of these colors does not appear on the test print, repeat the cleaning procedure. If nozzles still appear to be clogged, remove the cartridge and gently wipe the nozzle area sideways with a clean water-dampened cloth. If after several cleanings a color still does not appear on the test print, the cartridge may be damaged or empty and may need to be replaced.

Select the **Change** button to install a fresh, new ink cartridge or to switch back and forth between a previously used color cartridge and a previously used monochrome cartridge. After the cartridge has been replaced according to the instructions in Section 2-E, select either the **New Cartridge Installed** button or the **Old Cartridge Installed** button accordingly. These selections are necessary for the printer to accurately keep track of ink cartridge ink levels.

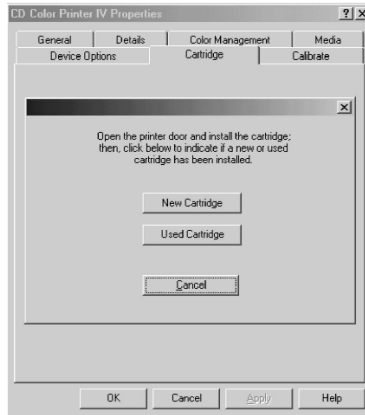

Calibrate

Select this button to display options for fine-tuning the position of your printed image and the size of a CD's non-printable center. The following gives a complete description of each of the Calibration options.

When facing the printer, the **Vertical** adjustment moves the printed image toward the back of the printer if a positive number is entered and toward the front of the printer if a negative number is entered. The **Horizontal** adjustment moves the printed image toward the left-hand side if a positive number is entered and toward the right-hand side if a negative number is entered. The **Center Size** adjustment enlarges the non-printable center if a positive number is entered and reduces its size if a negative number is entered. As a rule, an adjustment of 12 pixels is equivalent to approximately 1 millimeter. Once you have entered the optimum calibration values, you will most likely not need to change them again. The following diagram illustrates exactly how each of these adjustments affect the printed image.

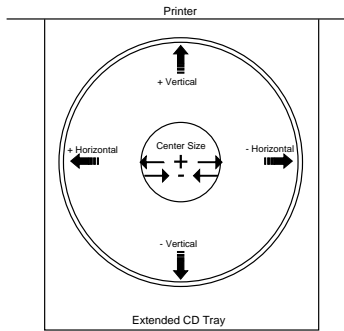

HINT: Notice the direction the Vertical and Horizontal adjustment arrows point within the Calibration window are representative of the direction the printed image moves on the CD.

NOTE: Your printer comes from the factory pre-calibrated to print the image in the center of the CD. You can use the **Centering Test Print** option if you need to fine-tune this location.

To do this, refer to the following steps:

1. Verify that a CD is installed in the printer. Also, verify that the printer is powered ON and that it is connected to your computer. (Do not use a cardboard CD template for best accuracy).
2. Click on the **Centering Test Print** button of the Image Placement box within the Calibration window. The printer will begin printing the calibration test print.
3. When the print is complete, rotate the CD 180° in the CD Tray and repeat step 2 using the same CD.



- When the second run of the print is complete, you should have a test print that looks like the following:

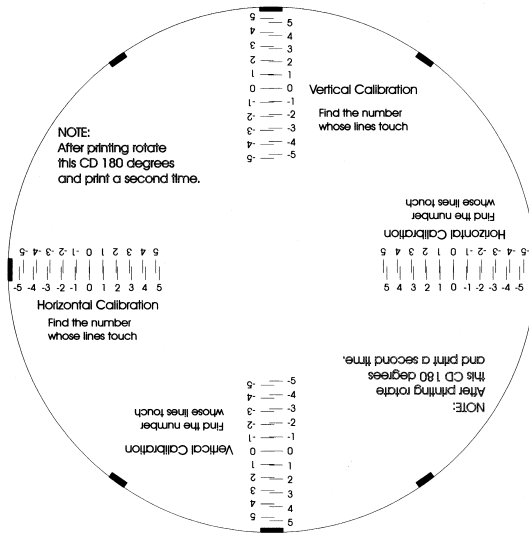

- Along the Vertical axis of the printed CD template, find the number whose lines touch. For example, in the above illustration, the number would be 0. Enter that number into the Vertical box of the Calibration window. Repeat this same step for the Horizontal axis. In the above illustration this number would be 0.
- Select the **OK** button. The numbers you entered will be sent and stored inside the printer's memory. Your images should now reflect any changes you made. Note that the numbers always are shown as 0,0 initially and these values sent are added to or subtracted from the currently stored offsets.

E. PRINTING A CD

Now that you have hooked up the printer, loaded the print supplies, and installed the printer driver, you are ready to print your first CD. Follow these steps to print your first image:

1. Go to your favorite graphics application program. Or, install and open the Windows CD creation software included with your printer.
2. Open or create the image file you wish to print. If using a program other than the included Windows CD creation software, you will need to create a custom page or canvas size in your program according to the type of label you intend to create. The following tips will help you do this:
 - If creating a label for a **CD**, set your page size to 4.567" x 4.567" (116 x 116mm). Although your image will appear square on screen, the printer driver will automatically crop your image to the round shape of a CD for printing. The driver will also automatically crop out the center 1.6" (41mm) of your image to accommodate a CD's non-printable center hub. If you would like to better visualize where the round outside edge and the round non-printable center of a CD will fall in relation to your image, simply draw one circle with a 4.567" (116mm) diameter and another with a 1.6" (41mm) diameter. Then, center both circles within your active page or canvas area. These circles will serve as a guide while designing your image. Be sure to delete these circles before printing.

3. Once you have created your image and are ready to print, select **Print Setup** (or the equivalent) from the program's File menu to verify that the printer driver settings are correct for your image. Be sure the proper Ink Cartridge options is selected according to the supplies you have installed in the printer. Once the driver is set, select **Print** from the program's File menu.
4. The printer driver will then begin to process the image. Depending upon the size of the image and the processing speed of your computer, processing time can take from several seconds to a few minutes.
5. Once processing is complete, the printer will begin to print. Print time will vary depending on whether you are printing with a color or monochrome cartridge and on which Print Quality setting you selected. When printing is complete, the CD Tray will automatically open and remain fully extended until the next print job is received.

Section 4: Interpreting the Printer's Indicator Lights

The **Power** and **Busy** LED indicator lights located on the top of the printer can tell you a lot about what is happening inside the printer. To accurately interpret what it means when these lights are on, off, or flashing, please refer to the following:

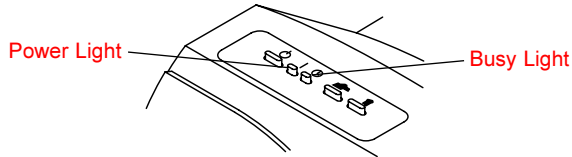

Power Light	Busy Light	Printer
on solid	off	Is ready to receive a print job.
on solid	on solid	Is processing and printing an image.
on solid	blinking slowly	Has received a print job and is waiting for you to load CD media or has a print media jam. If media loading is required, simply load media into the CD Tray according to Section 2-C and press the  CD Tray button to resume printing. If print media is jammed, clear the media from the printer and turn the printer OFF and ON to reset for the next print job.
both lights are blinking alternately with each other		Waiting for a cartridge to be installed and the Ink Cartridge button to be pressed. See Section 2-B or 2-E for more information on changing or replacing ink cartridges.
on solid	flashing rapidly	The tray or the carrier has stalled. Turn the unit OFF and ON again. You may need to clear an obstruction such as a jammed disc.

| Power Light **🕒 Busy Light** **Printer**

flashing rapidly	on solid	Has either the wrong cartridge or no cartridge installed. Make sure the proper ink cartridge is installed: Turn the printer OFF, cancel the job from the computer, turn the printer ON, and try again after installing proper cartridge.
Both lights are flashing at the same time rapidly and the printer has paused.		Ink Low Warning. You can either replace the cartridge now (see Section 2-B or 2-E) or you can press the CD Tray button to continue printing. Note: If you do replace the cartridge now then the ink levels will be cleared. (It assumes you replaced with a fresh cartridge.) If you instead press the CD Tray button to continue then the ink levels will <u>not</u> be cleared and you will not be warned again until a new cartridge is installed.

Section 5: Maintaining the Printer

The CD Color Printer IV is designed to require very little maintenance. Nevertheless, there are a few procedures you can perform on a regular basis or as needed to ensure your printer's best performance.

A. CLEANING THE INK CARTRIDGE NOZZLES

It may be necessary to clean the ink cartridge nozzles if the printer does not seem to be laying down ink evenly or if you suspect an ink cartridge nozzle has become slightly dried out or clogged. Refer to the cleaning procedure explained within the **Cartridge** button description of Section 3-D to clean the cartridge nozzles.

B. CLEANING THE CD TRAY AND PRINTER CASING

If ink gets on the printer's CD Tray, it may stain if left on the tray too long. To avoid this, simply wipe off any ink from the CD Tray as soon as you notice it. Use a lint-free cloth *slightly* moistened with water to wipe off the CD Tray. If necessary, use these same items to wipe off the outside casing of the printer. **Always disconnect your printer's power cord before cleaning.** Resume printer operation only after the printer is completely dry.

C. CLEARING A CD MEDIA JAM

If CD Media becomes jammed inside the printer, first press the  CD Tray button to try and eject the media. If this does not work, turn the printer power OFF and gently try to clear or remove the CD media manually.

D. TECHNICAL SUPPORT

If you have difficulty operating your CD Color Printer IV, the procedures in this manual should, in most cases, solve the problem. If you still have difficulty, contact the **technical support** number listed on the insert included in the supply pack.

Section 6: Technical Specifications

Model:	CD Color Printer IV
Print Method:	Ink-Jet
Printing Resolution:	1200 x 1200 dpi, 600 x 600 dpi, or 600 x 300 dpi, driver selectable.
Print Speed:	Depends upon percentage of coverage and print mode selected. About 216 seconds for 100% full-color coverage, SuperPhoto. About 134 seconds for 100% full-color coverage, Presentation 1200. About 106 seconds for 100%, full-color coverage, Best 600 About 68 seconds for 100% full-color coverage, Normal 600 (default). About 27 seconds for 100% full-color coverage, Fast 600. About 6 seconds for 15% black monochrome coverage, Fast 600.
Colors:	16.7 million or black monochrome
Ink Types:	3-Color (C, M, Y) and black monochrome (K)
Media Types:	Printable-surface CD-R, CD-RW, CD-ROM; DVD, DVD-ROM, DVD-R, DVD-RAM
Printer Driver:	Windows 95/98/Me and Windows 2000/XP
Data Interfaces:	Centronics-type parallel
Recommended System Requirements:	Pentium®-class computer or greater, 16MB RAM, 100MB free hard drive space
Control Interface:	TTL level signals for busy printing, tray open/close, etc.; available on rear-panel 6-pin DIN connector.
Maximum Print Width:	4.724" (120 mm)
Electrical Ratings:	30 VDC 0.5A
Adapter Types:	Three voltages: 100 VAC, 120-127 VAC, 220-240 VAC
Certifications:	UL, UL-C, CE, FCC Class B
Dimensions:	7.5"H x 10.5"W x 10.5"D (190mmH x 266mmW x 266mmD)
Weight:	8.5lbs (3.9 kg)
Temperature:	
Operating:	50°F to 109.4°F (10°C to 43°C)
Storage:	-4°F to 140°F (-20°C to 60°C)
Humidity:	
Operating:	20% to 80% (RH non-condensation)
Storage:	5% to 80% (RH non-condensation)
Warranty:	One Year

Appendix A: Interfacing Information

A. INTRODUCTION

The CD Color Printer IV is equipped with a standard 8-bit centronics-type parallel **interface port**. This communication port is the means through which the printer receives data from your computer. Contact technical support if you need more information on the **parallel port** specifications.

B. 6-PIN MINICIRCULAR AUXILIARY INTERFACE

The 6-pin minicircular **auxiliary interface** is used for connecting the printer with auxiliary equipment such as a CD transporter/ auto-loader.

Pin assignments are as follows:

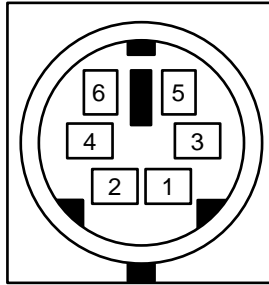

Uses 5v logic @ 5mA

Pin Number	Signal Description
1	Busy - Output is high when the printer is busy or moving the CD Tray.
2	Tray Out - Output is high when the CD Tray is fully ejected.
3	Tray In - Output is high when the CD Tray is fully inserted.
4	CD In - Output is high when the CD Tray is in and a CD is present.
5	Ground.
6	Tray In/Out - A low input moves the CD Tray in if it is out, and out if it is in.

TABLE A-1: Auxiliary Interface Pin Assignments

NOTE: Pins 1-4 are low if the printer is plugged in but the power has been turned off using the printer's Power Button

Index

Algebraic	18
Auxiliary Port	3, 31
Busy Light	2, 26
Calibrate	21
Cartridge	20
CDs	4, 6
CD Tray	2
CD Tray Button	2
Color Matching	18
Dither Mode	18
Ink Cartridges	4, 18
Ink Cartridge Button	2
Ink Saturation	19
Interface Port	3, 30
Manual Load	19
Media	18
Parallel Port	3, 11, 30
Print Quality	18
Printable CDs	4
Printer Driver	12
Power Button	2
Power Light	2, 26
Self Test	7
Technical Support	28
32-Bit Print Spooler	14, 20
Write Direct to Port	19

